

ARCADE MAX

Challenger



User
Manual



Contents

● Contents	1
● Package Contents	2
● Get to Know Your Machine	3
● Powering Up and Powering Down	8
● Initial Set Up	15
● Connecting to the Internet	18
● Using the Main Menu	21
○ Basic Menu Controls	22
○ Selecting a Game to Play	23
○ Adding a Favourite	23
● Search Functionality	24
○ Using the Search Functionality	25
● Background Download Mode	26
○ Background Download Mode Controls	27
○ How To Use	28
● In-Game Controls	31
○ Pause Menu	33
○ Saving and Loading a Game	34
● About “States”	34
● How to Use	35
● System Settings	36
○ Accessing the Settings Menu	37
○ Basic Menu Controls	38
○ Outline of Settings Menu Options	39
○ Game Setting Options	43
● Machine Specifications	47
● Troubleshooting	49

Package Contents

When you've unpackaged the machine, check below to ensure you have everything listed before getting started.



- A** ArcadeMAX Challenger Machine
- B** Wireless Keyboard + Dongle
- C** Power Cable
- D** Access Keys (attached to joystick)
- E** Instruction Booklet
- F** SSD Card Reader + USB Cable

Get to Know Your Machine

Your machine has several external controls and components to get familiar with.

Front

Master Power Switch (Top)



Screen

Gameplay Controls

PC Power Button

Front Access Door

Back



Getting Inside

If you need to access the interior components (for accessing settings or troubleshooting), there are 2 ways of getting access:

Front Access Door

Use the access keys to open the front access door (highlighted). Opening the front access door gives easy access to:

- The settings switch
- Volume Controls

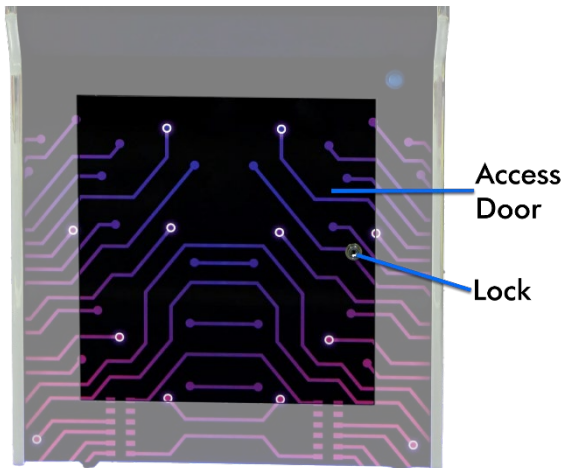

Rear Access Door

Use the access keys to open the rear access door (highlighted).
Opening the rear access door gives access to:

- Main Board
- Electrical Connections



Wheels and Feet



Your ArcadeMAX system is on castor wheels that allow for easy moving of the machine and 4 retractable feet that can keep the machine in place.

The retractable feet are on screw threads that can be turned either by hand or with a 22mm spanner. Use the spanner to turn the feet to the desired position.

Powering Up and Powering Down

The machine requires a single wall power socket to operate.

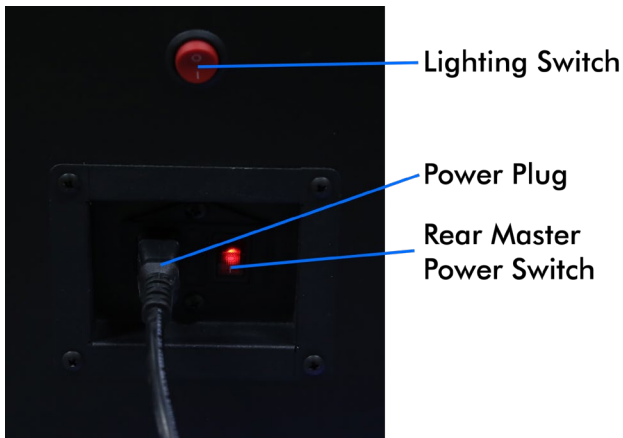

Plug the power cable into the wall power socket, then into the power plug on the rear of the machine.

Switch On



Flip both
power switches

Enable power to the machine by flipping both Master Power Switches to on. One switch is next to the power plug. The second is on the top of the machine. **Both switches should glow when switched on.**

Turning On the Internal PC

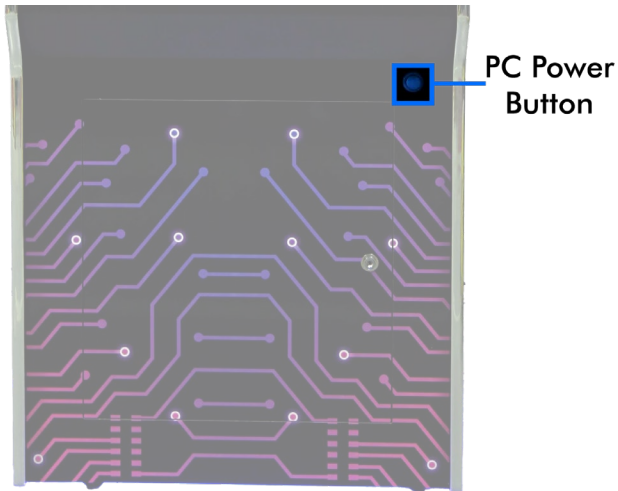

Power the internal PC up by pressing the PC Power Button on the front of the machine.

Power the internal PC down by pressing the Power Button once you have finished using the machine.

WARNING - The internal PC MUST be powered down before flipping either master power switch. Failure to do so could result in corrupted system settings.

Controlling the Lights:

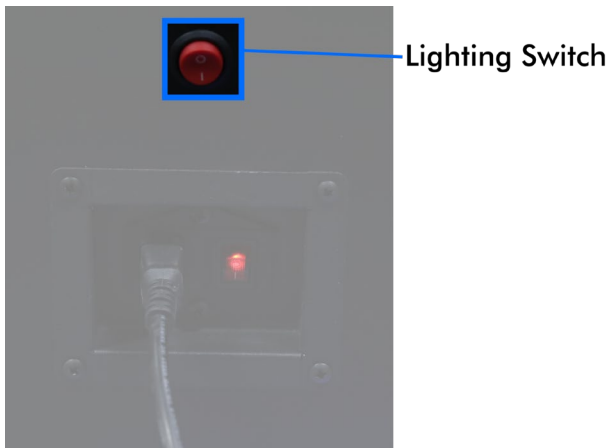

This ArcadeMAX machine includes lighting on the underside of the cabinet that can be turned on or off depending on your preference. Flip the lighting switch on the back of the machine to switch the lighting either on or off.

The lighting can be switched and left on regardless of whether the machine's internal PC is switched on or not allowing for games room ambience when the machine is not in use.

Volume Control

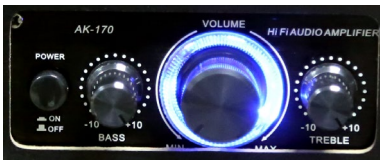

Your machine's sound amplifier controls are accessible inside the front access door of the cabinet. The sound can be switched on or off with the button on the left. The main volume dial will be illuminated when switched on.

You have 3 dials to adjust the bass, treble and overall volume.

SSD Card Reader

Your machine also comes with a small reader for SSD cards. Whilst this is not used in typical operation of your machine, it should be retained for troubleshooting purposes when in contact with technical support.

Gameplay Controls

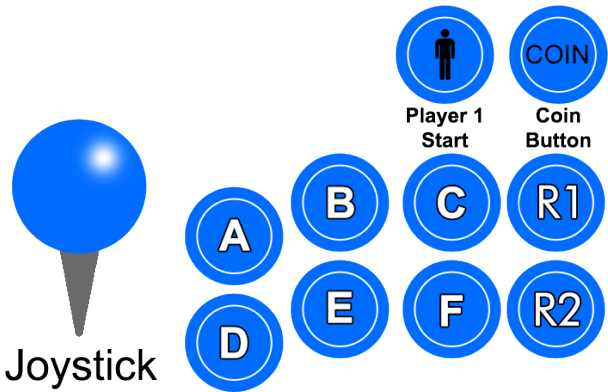

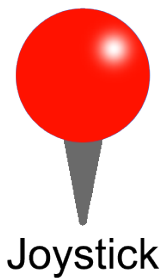

Player 2
Start



Pause



Initial Set Up

Your system will load the main ArcadeMAX games menu once it is fully booted up.

You will need to set up the machine's internet connection and wireless keyboard before being able to proceed further.

Connecting the Included Keyboard



Whilst not necessary for most games, your ArcadeMAX machine includes a wireless keyboard with built-in trackpad. This is needed in order to access certain machine settings.

The keyboard is easy to set up, requiring one AA battery (not included) and the included Keyboard dongle.

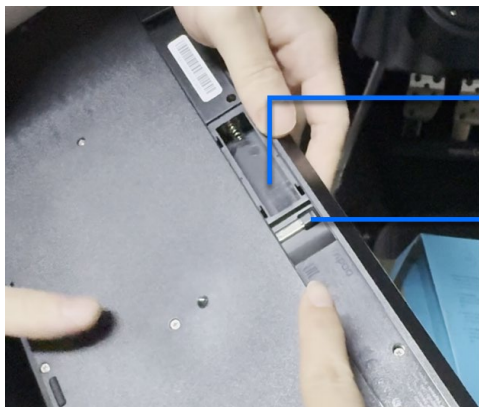

Battery
Compartment

Wireless
Dongle

1. To set up, Remove the battery cover on the back of the keyboard and insert 1 AA battery. The Keyboard Dongle can be found within the battery compartment and can be stored here when not in use.



2. Plug the keyboard dongle into the front of the machine using the front USB port and switch on the keyboard using the on/off switch. It will automatically connect to the machine. You can verify a connection has been made by using the trackpad to move a mouse cursor around the screen.
3. The bottom of the touch pad features buttons that allow you to click on or otherwise interact with the system.
4. You can switch the keyboard off when not in use to preserve battery life.

Connecting to the Internet

To use the machine and download games to play, you must connect your machine to the internet. Your ArcadeMAX machine can get online in one of two ways:

- Wired ethernet connection (More stable and reliable)
- Over Wi-Fi (More convenient)

Connecting via Ethernet Cable

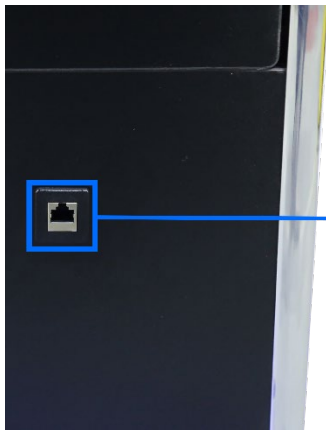

Network
Connector
Port

To connect the machine to the internet via a wired connection, plug a network-connected ethernet cable into the back of the machine into the Network Connector Port until it clicks. You'll be online and ready to start downloading games.

CAUTION

Be aware of moving the machine when connected using a wired internet connection so as not to strain the cable. Tugging at the cable can damage the cable, the plug or the machine's network connector.

Connecting Via Wi-Fi

In order to connect the machine to a Wi-Fi network, you will need to use the machine's included wireless keyboard (see above for details on use and how to connect)

Access the machine's Wi-Fi settings by hitting **ESC** on the keyboard to leave the main games menu and then click the Wi-Fi settings icon in the bottom right of the screen. Look for the following icon:



You can use this to find your own home Wi-Fi network and input any required credentials.

Return to the games menu by double clicking the **WPlayer.exe icon** on the desktop.

Once complete, your machine will be online and ready to start downloading games.

You can check your internet connectivity strength by referring to the Wi-Fi indicator in the top right of the machine's main games menu.

Using The Main Menu



When switched on, your machine will automatically load the main games menu.

The main menu on the ArcadeMAX system is your home base for playing games on your system. Use it to look through the games list, search for games or even assign favourites.

Basic Menu Controls



Joystick

Up: Move up 1 selection

Down: Move down 1 selection

Left: Move back one page

Right: Move forward one page



Player 1 A Button

Play current selection



Player 1 C Button

Add current selection to favourites



Player 1 Start Button

Search Tab (Shortcut)

Selecting A Game To Play

Use the Player 1 joystick to navigate through the lists, then select your game with the **Player 1 A button**. The game will download to your system and then launch.

The Main Games Menu is also split into different tabs for ease of navigation.

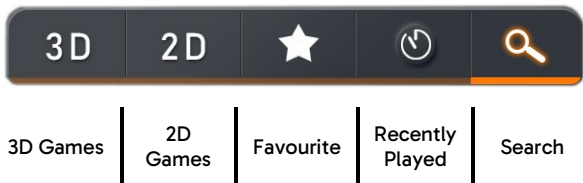

Highlight a tab with the **Player 1 Joystick**, then move left or right to scroll through the tabs.

Adding A Favourite

Any game in the games list can be added to your own favourites list. Press the **Player 1 C Button** on any highlighted game to add it to your favourites list.

Favourited games will display a star next to their name.

You can view a collection of all games you have added to your favourites in the “Favourites” tab in the main menu.

Search Functionality



The system includes a very useful search function that can help you find or narrow down your selection in seconds, without having to scroll through the entire games list. You can shortcut to this menu by pressing the **Player 1 Start Button** Or by navigating to the search tab (on the far right) at the top of the games list.

Using the Search Functionality



In this menu, you can use the [Player 1 Joystick](#) and [Player 1 A Button](#) to type what you want to search for with the on-screen keyboard. There is no need to input spaces. You can delete letters using the backspace key on the on-screen keyboard.

You also have the option of toggling the genre using the genre toggles (press the [Player 1 A Button](#) whilst on a highlighted option to toggle it on or off)

As you enter in letters, the list on the left will begin to fill with games that match your search term. Jump to the search results with the [Player 1 Start Button](#), then use the [Player 1 Joystick](#) and [Player 1 A Button](#) to select and play any of the search results.

You can add a highlighted game to your favourites by pressing the [Player 1 C Button](#).

When you exit the game, you will return to your original search results, where you can play another result, search for another game or navigate back to the main games lists.

Background Download Mode

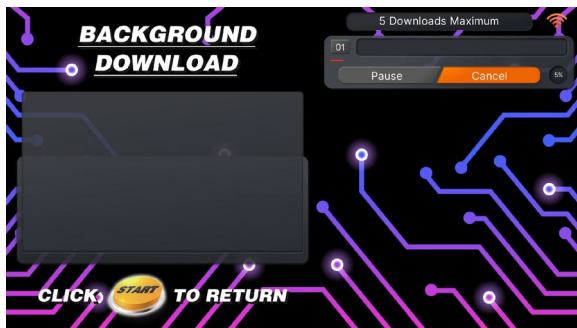

This setting must be enabled in settings before it is available. Please refer to page 42 for details.

Under default settings, the machine will load and delete each game individually.

With the Background Download setting enabled, you have the option of downloading up to 5 games in the background whilst playing other games, which can then be started immediately once your current game has finished.

Background Download Mode Controls



Coin Button (In Main Menu)

**Open
Downloads
List**



Joystick

Move



Player 1 A Button (In Downloads List)



**Confirm
Current
Selection**



Player 1 Start Button (In Downloads List)

**Go Back /
Exit**

Menu Buttons

	<p>Pause the currently selected download.</p>
	<p>Cancel/Abort the currently selected download</p>
	<p>Play the currently selected download</p>

How To Use

Select a game from the main menu or your search results as normal and it will be added to your active download list.

From here, you can check the progress of your download, pause the download or cancel the download.

You can download up to 5 games at any one time.



When the game is downloaded and ready to play, navigate to the game's "open" option, and press the **Player 1 A Button** to start the game.

You also have the option of returning to the main menu to select another game to download (by pressing the **Player 1 Start Button**).

You can check the status of games you have begun downloading at any point from the main menu by pressing the **Coin Button**.

Note - Like in the default mode, games will automatically be deleted from the machine once they are closed.

This page is intentionally left blank.

In-Game Controls



Player 1 Start Button

Insert virtual coin and start a 1-player game



Player 2 Start Button

Insert virtual coin and start a 2-player game



Coin Button

Insert additional virtual coins



Pause Button

Bring up Pause Menu



Joystick
(In Pause Menu)

Up: Move up selection

Down: Move down selection



Player 1 A Button

Confirm selection (In Pause Menu)

When a game is loaded, a 1 player game can be started with the **Player 1 Start Button**. A 2-player game can be started with the **Player 2 Start Button**. Pressing either of these buttons also acts as inserting a virtual coin, should the game you're playing require them.

You can add additional virtual coins by pressing the **Coin Button**.

Pause Menu



A game can be paused or quit at any time by pressing the **Pause Button**, where you will be given the option to resume your current game, exit back to the main menu or save or load a game.

Note: It is important to note that any game file downloaded to the system for play is not permanently saved to the system's internal storage. All games by default are deleted immediately upon exiting and will need to be downloaded again.

Please refer to the Game Delete option instructions in the system settings section of this manual (see page 46) if you wish to save and store games indefinitely to the system's internal storage.

Saving and Loading a Game

Note: Only certain games will keep track of high scores. In most cases, every time a game is loaded, it is loaded 'from fresh' meaning that high scores are not saved between games unless saved manually by the player using the saving and loading system.

The saving and loading system may not be supported by every game.

The saving and loading system allows you to save your progress at any point on certain games, and then return to that point at a later time. This is achieved by saving a "State".

About "States"

On this ArcadeMAX system, a "State" can be described as a specific point or moment when in the game. When you load a state, you will return in the game to the exact moment where you saved it.

States can be saved or loaded at any point of the game.

On this system, there can only be one state per game. Each new state you save will overwrite the last.

Save states are unaffected by games being deleted from the system and will be maintained if the game is downloaded again.

How to use

To access the save and load system, pause the game you're currently playing using the **Pause button**, then save the state by scrolling to the "Save State" option and pressing the **Player 1 A Button**.

To load the last state you saved, pause the game using the **Pause button**, then select the "Load State" option from the menu using the **Player 1 A Button**.

System Settings

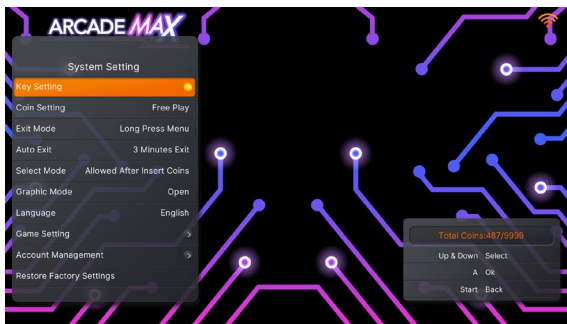

System settings are changed at a user's own risk. It is recommended to perform the **"Restore Factory Settings"** function (see page 41) on the machine if performance becomes erratic.

This machine has a range of different options that can be changed or modified to change the machine's function to the user's preference.

To access the machine's settings, you must press the machine's settings switch.

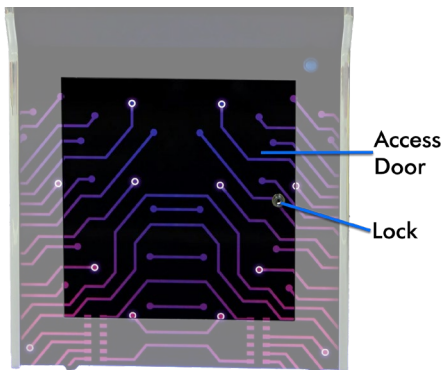

On the ArcadeMAX Challenger, the settings switch can be found inside the front access door.



Press the settings button once to access the settings menu.

Basic Menu Controls



Joystick

Move



Player 1 A Button

**Confirm
Selection/Toggle**



Player 1 Start Button

Go Back / Exit

Outline of Settings Menu Options

Key Setting

- **Keys Testing**

Use this mode to have a visual representation of how the machine responds to inputs. The relevant button will light up on the screen when it is pressed.

- **Key Definition**

Use this mode to remap any of the player buttons to different inputs. You can switch between the machine's default button mapping or your own mapping choices.

Coin Setting

- This setting should always be set to Free Play

Exit Mode

These options allow you to specify a shortcut to quitting the games without having to use the pause menu.

- Start + Coin
 - Press the Player 1 Start Button and the Coin button simultaneously to quit the game.
- Long Press Menu
 - Press and hold the Player 1 Start Button to quit the game.

Auto Exit

Use these options to specify shortcuts or a timeout to exit a game.

- **3 Minutes Exit**
 - Will exit the game automatically after 3 minutes of inactivity.
- **Closed**
 - No shortcuts or automatic timeout will be implemented.

Select Mode

- This setting should always be set to **“Always Allowed”**

Graphic Mode

Use this mode to change the graphics fidelity of certain games.

- **Open**
 - Improved graphics performance.
 - May impact the overall performance of more technically intensive games
- **Closed**
 - Basic graphics performance
 - Most stable mode for running games.

Language

Toggle through the machine’s language settings

Game Setting

Multiple options for changing numerous menu and game settings (see page 43 for more details)

Account Management

Change settings pertaining to various admin-related options and metrics.

- **Clear Coins**
 - Cancel out any virtual coins that have been applied to the system
- **Change Password**
 - Change the system's default Admin password.
 - The default admin password for the machine is 11111111
- **Reset Password**
 - Input the current password to reset the machine's password to the default: 11111111

Restore Factory Settings

If you want to return every system setting to its default, select this option, then confirm your decision in the popup that appears.

Please note that any account management settings (such as passwords) will not be affected by this reset.

Background Download

Use this option to enable background downloading of games (refer to page 26 for details)

- **Closed**
 - Each game is loaded and deleted on an individual basis
- **Open**
 - Up to 5 games can be downloaded in the background.

Game Setting Options

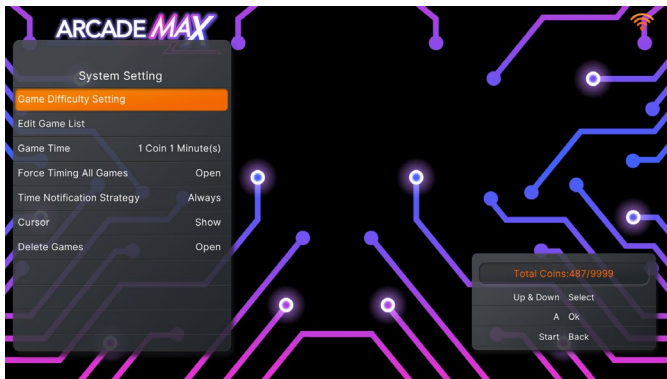

The Game Setting option in the settings menu can be used to modify a wide range of settings, as listed below. You can return to the main settings list at any time using the Player 1 Start button.

Game Difficulty Setting

Use this setting to modify the difficulty of supported games in the games list.

- Navigate the list using the Player 1 Joystick to highlight the game you want to modify.
- Press the **Player 1 A Button** to increase the difficulty. (will reset to 0 beyond the maximum possible number)

- Press the **Player 1 B Button** to increase the number of lives (will reset to 0 beyond the maximum possible number)
- Press the **Player 1 C Button** to apply the current settings to all games in the games list.
- Press the **Player 1 Start Button** to exit and save these settings.

Edit Game List

Use these settings to hide certain games from the main games list from view.

- Navigate the list using the **Player 1 Joystick** to highlight the game you want to modify.
- Press the **Player 1 A button** to hide the currently highlighted game.
- Press the **Player 1 B button** to hide every game in the list.
- Press the **Player 1 C button** to show every game in the list.
- Press the **Player 1 Start Button** to exit and save these settings.

Game Time

This setting is only used with specific coin settings. Please ignore this option.

Force Timing All Games

This option will force all games to operate on a timer, closing them once time is elapsed. For Free-Play purposes, ensure the “Closed” option is selected.

Time Notification Strategy

This option pertains to the Force Timing option above.

- **Always**
 - The remaining time is always displayed on-screen
- **Default**
 - The remaining time is only shown when either Start Button is pressed.

Cursor

This option will either hide or display a cursor on screen.

- **Show:** Cursor will be displayed.
- **Hide:** Cursor will be hidden.

Delete Games

This option will control how the system deals with downloaded games once they are closed.

- **Open**
 - Games will be deleted immediately upon closing.
- **Closed**
 - Games will be saved indefinitely to the machine's internal storage. You must accept the conditions of the popup before this feature can be enabled.

WARNING - Disabling the machine's game deletion functionality can cause legal issues pertaining to copyright. Users choosing to utilise this functionality are accepting full legal responsibility for doing so.

Machine Specifications

CPU	Intel Celeron N5095
RAM	4GB DDR4
Installed SD Card	240GB
System Base	Pandora
Video	HDMI (1280 x 720 - 720P)
Connectivity	<ul style="list-style-type: none"> ● Wireless Keyboard ● Spare USB for Dongle ● Wireless Internet ● Wired Ethernet
Control Peripherals	<ul style="list-style-type: none"> ● Player 1 Control Buttons (x9 (inc start button)) ● Player 2 Control Buttons (x9 (inc Start Button))
Installed Languages	<ul style="list-style-type: none"> ● English ● Korean ● Spanish ● Chinese
Custom Button Mapping	YES
Changeable Game Settings	<ul style="list-style-type: none"> ● Game Difficulty ● Number of Lives
Emulator Search Parameters	<ul style="list-style-type: none"> ● Dreamcast ● Nintendo 64 ● MAME ● Playstation Portable ● Playstation ● Famicom ● Super Famicom

	<ul style="list-style-type: none"> ● Gameboy Advance ● Megadrive ● Final Burn Alpha ● PC Engine ● SEGA NAOMI ● Atomiswave ● SEGA Saturn ● Model 2
Game Category Search Parameters	<ul style="list-style-type: none"> ● Fighting ● Shooting ● Puzzle ● Action ● Sport ● Racing ● 4 Player ● Lightgun ● Trackball
Coin Function	Free Play
Working Environment	5°C - 45°C/ Humidity 30% - 90%

Troubleshooting

Issue	Possible Cause/Solution
No Sound	Check the machine's amplifier is turned on and is turned up.
No Image Signal	<p>The cable connecting the main board to the monitor may have become disconnected or faulty.</p> <p>Verify the main board and the monitor are connected together and if so, replace the HDMI cable running from the main board to the monitor.</p>
Unable to download games	<p>The games cloud may temporarily be down, or the machine may be having internet connectivity issues.</p> <p>Check the machine's internet connectivity (with the Network indicator on the main menu) and update Wi-Fi settings if necessary.</p>
Buttons not working	First, verify if a button is working or not in the game's settings via the Keys Test (see page 39). Contact our team and we can help you further.

If you have any other issues, or any of the above does not solve your issue, contact us (Contact details on the back of this booklet)



Any other questions?
Tel - 0800 622 6464
sales@homeleisuredirect.com

ARCADE **MAX**